

CR 4200

Thermoreactor

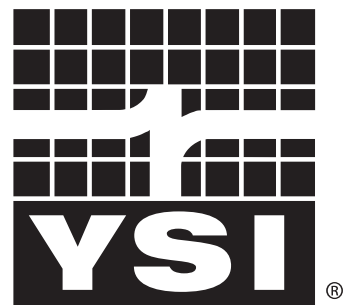

a xylem brand



Note

For the most recent version of the manual, please visit www.ysi.com.

Contact

YSI
1725 Brannum Lane
Yellow Springs, OH 45387 USA
Tel: +1 937-767-7241
800-765-4974
Email: environmental@ysi.com
Internet: www.ysi.com

Copyright

© 2012 Xylem Inc.

CR 4200 - Contents

1	Overview	5
1.1	Components of the thermoreactor	6
2	Safety	7
2.1	Authorized use	8
2.2	General safety instructions	8
3	Commissioning	11
3.1	Scope of delivery	11
3.2	Initial commissioning	12
4	Basic principles of operation	15
4.1	Operating and display elements	15
4.1.1	Keys	16
4.1.2	Display	17
4.1.3	Control lamps (LEDs)	17
4.2	Operating modes	18
5	Operation	19
5.1	Inserting the reaction cells	19
5.2	Starting a temperature program	19
5.3	Starting the second temperature program	21
5.4	Stopping a temperature program	22
5.5	Temperature test program	22
5.5.1	Starting the temperature test program	23
5.5.2	Downloading the test report to an external printer/PC	24
5.6	Settings	26
5.6.1	Editing a temperature program	26
5.6.2	Setting the display contrast	27
5.6.3	Setting the timer for the reaction time	27
6	Maintenance, cleaning, disposal	29
6.1	Maintenance	29
6.2	Exchanging the fuses	29
6.3	Cleaning the enclosure	30
6.4	Cleaning the thermoblock of spilled cell contents	30
6.5	Disposal	30
7	What to do if...	31

8 Technical Data33

9 Accessories/Options35

10 Index37

11 Contact Information39

 11.1 Ordering & Technical Support 39

 11.2 Service Information 39

1 Overview

The thermoreactor CR 4200 is a dry temperature control device for laboratory use. It facilitates and secures the digestion using reaction cells.

The thermoreactor has 8 fixed temperature programs.

- 1: 148 °C for 120 minutes
- 2: 120 °C for 30 minutes
- 3: 120 °C for 60 minutes
- 4: 120 °C for 120 minutes
- 5: 100 °C for 60 minutes
- 6: 148 °C for 20 minutes
- 7: 150 °C for 120 minutes
- 8: 100 °C for 30 minutes

8 more temperature programs can be set up freely. The reaction temperature can be adjusted from room temperature to 170 °C, the heating time from 0 to 180 min.

The thermoreactor takes 24 reaction cells with an outer diameter of 16 mm.

The thermoreactor CR 4200 has two independent thermoblocks and thus enables two temperature programs to run simultaneously.

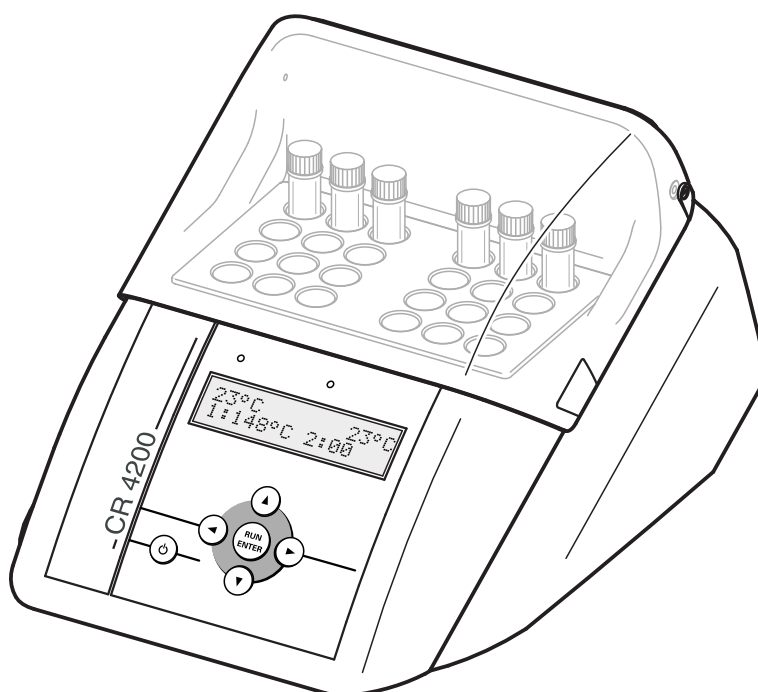

1.1 Components of the thermoreactor

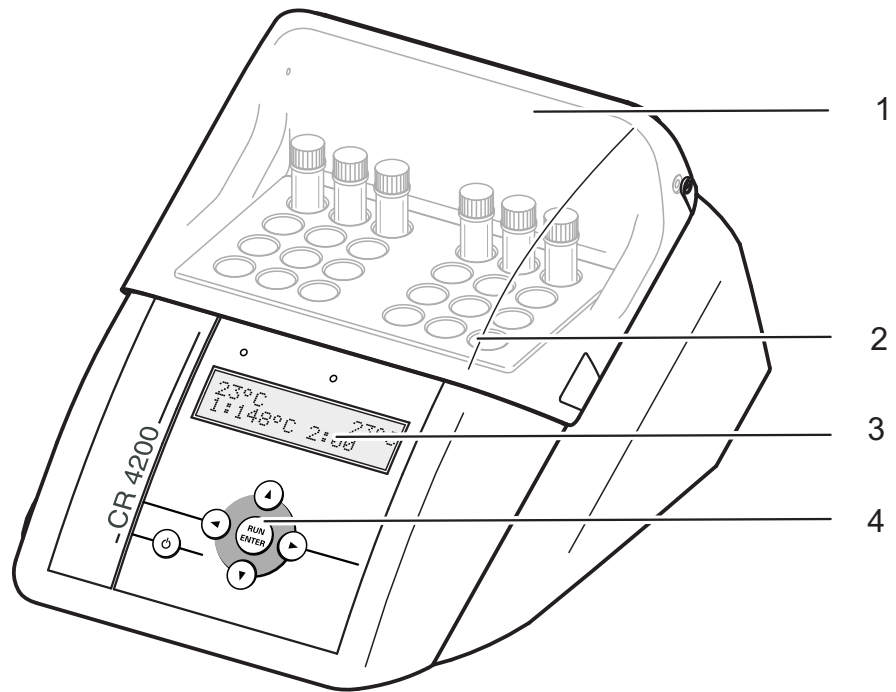

1	Protection cover
2	Thermoblock with cell shafts
3	Display
4	Keypad

2 Safety

This operating manual contains basic instructions that you must follow during the commissioning, operation and maintenance of the thermoreactor. Consequently, all responsible personnel must read this operating manual before working with the thermoreactor. The operating manual must always be available within the vicinity of the thermoreactor.

Target group

The thermoreactor was developed for use in the laboratory. Thus, we assume that, as a result of their professional training and experience, the operators will know the necessary safety precautions to take when handling chemicals.

General safety instructions

The individual chapters of this operating manual use the following safety labels to indicate different levels of danger:



Warning

indicates instructions that must be followed precisely in order to prevent serious dangers to persons.



Caution

indicates instructions that must be followed precisely in order to avoid slight injuries or damage to the instrument or the environment.

Other labels



Note

indicates notes that draw your attention to special features.



Note

indicates cross-references to other documents, e.g. application reports.

2.1 Authorized use

The authorized use of the thermoreactor is exclusively the heating of samples in cells in a laboratory. The technical specifications as given in chapter 8 TECHNICAL DATA must be observed. Only the operation and running of the measuring instrument according to the instructions given in this operating manual is authorized. Any other use is considered **unauthorized**.

2.2 General safety instructions

This thermoreactor is constructed and tested in compliance with the EN 61010 safety regulations for electronic measuring instruments. It left the factory in a safe and secure technical condition.

Function and operating safety

The smooth functioning and operational safety of the thermoreactor can only be guaranteed if the generally applicable safety measures and the specific safety instructions in this operating manual are followed during operation.

The smooth functioning and operational safety of the thermoreactor can only be guaranteed under the environmental and electrical operating conditions that are specified in chapter 8 TECHNICAL DATA.

If the thermoreactor was transported from a cold environment to a warm environment, the formation of condensate can impair the functioning of the measuring system. In this event, wait until the temperature of the thermoreactor reaches room temperature before putting the thermoreactor back into operation.



Caution

The thermoreactor is only allowed to be opened by personnel authorized by.

Safe operation

If safe operation is no longer possible, the thermoreactor must be taken out of service and secured against inadvertent operation. Safe operation is no longer possible if the thermoreactor

- has been damaged in transport
- has been stored under adverse conditions for a lengthy period of time
- is visibly damaged
- no longer operates as described in this manual.

If you are in any doubt, please contact the supplier of the thermoreactor.

Obligations of the purchaser

The purchaser of this thermoreactor must ensure that the following laws and guidelines are observed when using dangerous substances:

- EEC directives for protective labor legislation
- National protective labor legislation
- Safety regulations
- Safety datasheets of the chemical manufacturers.

3 Commissioning

3.1 Scope of delivery

- Thermoreactor CR 4200
- Connection cable for mains connection
- Operating manual



Warning

Always keep the original packing including the inner packing. If you have to transport the instrument, the packing protects the instrument optimally from hard shocks.

The original packing is also required for the appropriate return transport of the instrument if it has to be repaired.

Please note that the warranty does not cover damage caused by inappropriate transport.

3.2 Initial commissioning



Note

The thermoreactor works at an ambient temperature of +5 °C to +40 °C. When the thermoreactor was transported from a cold environment to a warm environment, condensate may occur and cause a malfunction. Wait until the thermoreactor has adjusted to the new environmental conditions before putting it into operation again (see also chapter 8 TECHNICAL DATA).

Setting up the thermoreactor

1	Place the thermoreactor firmly onto a heat-resistant underground.
2	Make sure that there is enough space between the thermoreactor and other instruments or devices that are heat-sensitive.

Adjusting the mains voltage

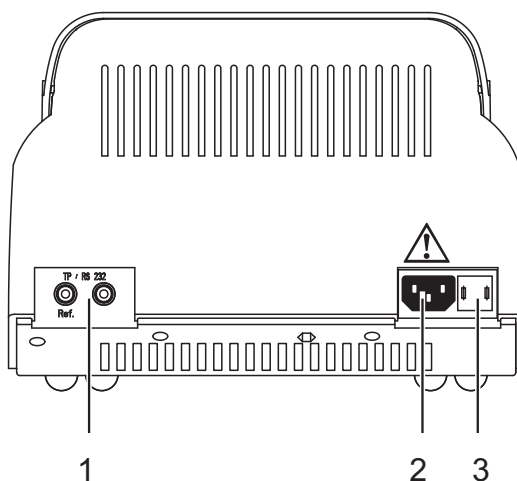

3	Check whether the arrow on the housing points to the mains voltage (115 or 230 V) given on the fuse holder (3) that is provided by the mains.
4	If the wrong mains voltage is set, perform steps 5 to 7.
5	Pull out the fuse holder (3).
6	Turn the fuse holder (3) so that the arrow on the housing points to the mains voltage (115 or 230 V) provided by the mains.
7	Push the fuse holder (3) in completely.

Connecting the mains cable

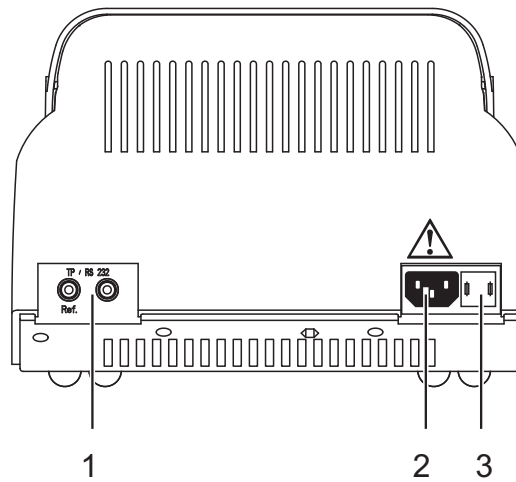

- | | |
|----------|------------------------------------|
| 1 | Socket for temperature probe or PC |
| 2 | Socket for mains plug |
| 3 | Fuse holder |

- | | |
|----------|--|
| 8 | Connect the mains cable to the socket 2 on the thermoreactor. |
| 9 | Connect the mains cable to an easily available mains socket. The thermoreactor is now in the Standby mode. The display shows the name of the instrument. |

CR 4200 U X.XX

The thermoreactor is ready for operation.

4 Basic principles of operation

This chapter provides you with basic information on how to operate the thermoreactor.











4.1 Operating and display elements

Using the six keys of the keypad (see section 4.1.1) you control the thermoreactor.

Temperature values, available temperature programs or settings can be viewed in the display (see section 4.1.2).

The control lamps above the operating panel are assigned to the left-hand or right-hand thermoblock. Their color (red or green) and their state (flashing or illuminated) show the current operating state of the thermoreactor (see section 4.1.3).

4.1.1 Keys

Key	Meaning
	On/off switch
	<ul style="list-style-type: none"> ● Making or confirming a selection or <ul style="list-style-type: none"> ● Starting the timer for the reaction time (active temperature program).
 	Keep  depressed and simultaneously press  : Changing to the <i>SETUP</i> menu from the Standby mode
 	<ul style="list-style-type: none"> ● Selecting the thermoblock (program selection) or <ul style="list-style-type: none"> ● Changing between the temperature setting and the reaction time setting (in the <i>SETUP</i> menu) or <ul style="list-style-type: none"> ● Canceling the active temperature program
 	<ul style="list-style-type: none"> ● Selecting the temperature program (program selection) or <ul style="list-style-type: none"> ● Changing settings and switching between settings (<i>SETUP</i>) ● Starting the scrolling through settings by keeping the key depressed

4.1.2 Display

Example: Program selection

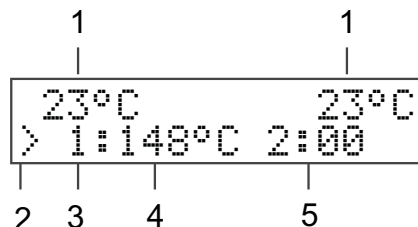

1	Temperature in the left-hand or right-hand thermoblock
2	< (left) or > (right) indicates the thermoblock selected
3	Number of the temperature program
4	Specified temperature
5	Reaction time in hours and minutes

4.1.3 Control lamps (LEDs)



The control lamps above the operating panel are assigned to the left-hand or right-hand thermoblock and indicate the current operating state.

LED	flashes	is illuminated
green		Program selection
red	active temperature program: heating period or cooling period	active temperature program: reaction temperature reached
red and green	active temperature program: program canceling selected	

If the control lamps are off the thermoreactor is in the Standby mode.

4.2 Operating modes

The thermoreactor has three operating modes:

- Standby
The display shows the model and version number of the thermoreactor.
Using the  and  keys simultaneously takes you to the *SETUP* menu. There you can:
 - Edit the 8 temperature programs and the temperature test program (setting the temperature and reaction time for the programs 9 to 16 and T, see section 5.6.1)
 - Set the display contrast (*CONTRAST:0* to 9, see section 5.6.2)
 - Activate a manual confirmation before the timer for the reaction time is started (*START TIMER:MAN.* or *AUTO*, see section 5.6.3)
- Program selection
After switching on with  the display shows the current temperature values for each thermoblock. The second display line shows the temperature programs and the temperature test program to be selected if a reaction time of at least one minute has been set (see section 5.6.1). The control lamp above the display for the selected thermoblock lights up green.
- Active temperature program
The display shows the current temperature values for each thermoblock. The control lamp above the display lights up or flashes red.

5 Operation

5.1 Inserting the reaction cells

The reaction cells can either be inserted at room temperature or when the thermoreactor has been preheated.



Caution

When dealing with chemicals always follow the safety data sheets and the regulations for prevention of accidents.



Caution

Observe the analysis specifications of the test sets used.



Warning

The thermoblock can become very hot (170 °C). There is danger of burning when the thermoblock is heated up.



Note





When cold reaction cells are inserted in the preheated thermoblock it can cool down by approx. 3 °C.

- | | |
|---|--|
| 1 | Insert the filled reaction cells in the cell shafts. |
| 2 | Close the protection cover. |

5.2 Starting a temperature program

- | | |
|---|--|
| 1 | Switch the thermoreactor on with  . |
|---|--|

23°C	23°C
< 1:148°C	2:00

- | | |
|---|---|
| 2 | Select the thermoblock with   .
An arrow < or > in the display indicates the selected thermoblock.
The control lamp of the thermoblock lights up green. |
| 3 | Select a temperature program with   .
You can select from 8 predefined temperature programs, up to 8 user-defined temperature programs and a temperature test program (see section 5.6.1). |

```

23°C          23°C
< 4:120°C  2:00

```

- 4 Start the displayed temperature program with .
The control lamp for the selected thermoblock flashes red.
The nominal reaction time (in hours and minutes) appears on the display.



Note

The reaction temperature is reached when the temperature in the thermoblock is in a range of ± 1 °C around the adjusted temperature for two minutes constantly. The control lamp of the thermoblock will then light up red.

Sequence with automatic timer

If the start of the timer for the reaction time has been set to automatic in the *SETUP* menu (*START TIMER:AUTO* see section 5.6.3), the reaction time automatically starts after the reaction temperature has been achieved. The reaction temperature is kept constant during the reaction time.

After the reaction time has expired the control lamp flashes red. The temperature program is finished.

The thermoreactor is in the program selection mode.

As soon as the thermoblock has cooled down to under 50°C, the control lamp switches itself off.

Sequence with manual timer

If the start of the timer for the reaction time has been set to manual in the *SETUP* menu (*START TIMER:MAN*, see section 5.6.3), an *S* is displayed in front of the nominal reaction time. With this setting the thermoreactor controls the temperature until the timer for the reaction time is started by pressing .

```

100°C          23°C
S2:00

```

- 5 Start the timer for the reaction time with . The *S* in front of the reaction time disappears.

The reaction temperature is kept constant during the reaction time. The control lamp of the thermoblock will then light up red.

After the reaction time has expired the control lamp flashes red. Additionally, an acoustic signal sounds.

- | | |
|---|--|
| 6 | Using  confirm the end of the reaction time for each thermoblock. |
|---|--|

The temperature program is finished.
The acoustic signal is finished.
The thermoreactor is in the program selection mode.
As soon as the thermoblock has cooled down to under 50°C, the control lamp switches itself off.





5.3 Starting the second temperature program

For one thermoblock a temperature program was already started. The control lamp for this thermoblock flashes or lights up red. You can start a second temperature program for the second thermoblock.



Note

The temperature test program is not available.

- | | |
|---|--|
| 1 | Using  or  switch to the thermoblock that is not active. The control lamp of the non-active thermoblock lights up green. |
| 2 | Select a temperature program with   . You can select from 8 predefined temperature programs and up to 8 user-defined temperature programs. |

23°C	23°C
> 4:120°C	2:00

- | | |
|---|--|
| 3 | Start the displayed temperature program with  . The control lamp for the selected thermoblock flashes red. The nominal reaction time (in hours and minutes) appears on the display. |
|---|--|

The further program sequence is similar to that of the first temperature program (see section 5.2).

5.4 Stopping a temperature program

You can terminate a running program at any time.

- 1 Using ◀ or ▶ terminate the running temperature program for the thermoblock to be stopped.
The control lamp for the thermoblock flashes red/green.
The safety query *STOP?* is displayed.

54°C	23°C
STOP?	

- 2 Using  confirm the safety query *STOP?*.
The temperature program is finished.
The control lamp of the thermoblock will then light up green.
or:
Using ◀ or ▶ leave *STOP?* for the thermoblock to be stopped.
The query *STOP?* disappears from the display. The temperature program is continued.



Note

While *STOP?* is displayed the temperature program goes on running. As soon as a section of the temperature program is finished (e.g. after the end of the heating period or after the end of the reaction time), the *STOP?* display is overwritten.

5.5 Temperature test program

With the temperature test program, you can check the temperature in the thermoblock with the aid of an external temperature probe that is available as an accessory (see chapter 9 ACCESSORIES/OPTIONS). While the temperature test program is active, the display shows the current temperature of the selected thermoblock and at the same time the measured temperature value of the external temperature probe.

The thermoreactor functions correctly if the temperature of the external temperature probe does not deviate from the nominal temperature value by more than 2 °C.

If the deviations from the nominal value are greater, further measures can be necessary (see chapter 7 WHAT TO DO IF...).



Note





The external temperature probe has the same accuracy as the internal temperature sensor.

5.5.1 Starting the temperature test program



Note

All other temperature programs are blocked while the temperature test program runs.

1	Connect the external temperature probe to the socket at the thermoreactor (see chapter 3 COMMISSIONING).
2	Insert the external temperature probe in a cell shaft.
3	Switch the thermoreactor on with  .
4	Using   select the thermoblock in which the external temperature probe has been inserted. The control lamp for the relevant thermoblock lights up green. An arrow < or > for the selected thermoblock is displayed.
5	Using   , select the temperature test program <i>T</i> .

```

23°C          23°C
< T: 80°C    0:30
  
```

6	Using  start the temperature test program <i>T</i> .
---	---

```

100,3°C      0:30
100,5°C      0:10
  
```

The first display line shows the nominal measuring time and the temperature of the thermoblock. The second display line shows the temperature of the external temperature probe. After the nominal temperature has been reached, the measuring time is counted down in the second display line.

During the temperature regulation phase, the thermoreactor saves the measured temperature values of the external temperature probe in a test report every 60 seconds.

As soon as the temperature test is finished, "*PRINT*" appears on the display.

```

100.0°C      0:30
          PRINT
  
```

You can now output the measuring data of the temperature test to a PC or printer.

You have the following options now:

- Connect the thermoreactor with a PC and transmit the test report to a terminal program (see section 5.5.2).

- Connect the thermoreactor with a printer and download the test report to the printer (see section 5.5.2).
- Leave the temperature test program with .

The test report in the thermoreactor is erased in any case at the end.

5.5.2 Downloading the test report to an external printer/PC

To transmit the temperature test report to a printer or PC, a printer cable or PC cable is required (see chapter 9 ACCESSORIES/OPTIONS). You can record the test report with the aid of a so-called terminal program on the PC side.

Generally, a terminal program serves to establish a connection to a meter at a data interface and to communicate with the meter via a console on the display. A terminal program usually offers the possibility to save the contents of the console in a text file or print it. If the terminal program is connected to the thermoreactor, it can receive the temperature test report and display it on the console.

Terminal programs are available by different manufacturers for different operating systems. The "HyperTerminal" terminal program is included in Windows (versions 95 to XP). It is in the program menu under *Accessories*.

More detailed information can be taken from the user information of the terminal program.

Sample report

```
CR 4200 V.X.XX
Tref = 148 C
1: Tblock = 147.5 C
2: Tblock = 147.6 C
3: Tblock = 147.7 C
. . .
```

Downloading the test report

Precondition:

The temperature test is finished and *PRINT* is displayed (see page 5-23).

- 1 | Disconnect the external temperature probe from the thermoreactor.



Note

When connecting the PC or printer cable observe the cable poling. Data transmission is possible with the correct poling only.

Socket assignment



1 Ref
2 TxD

- | | |
|---|--|
| 2 | Connect the thermoreactor to the PC or printer. (Cable see chapter 9 ACCESSORIES/OPTIONS). To do so: <ul style="list-style-type: none"> ● plug the reference plug (unmarked) in the "Ref" socket (1). ● plug the signal plug (marked by a red ring) in the socket (2). |
| 3 | Start the terminal program on the PC. |
| 4 | Set the following transmission data in the terminal program: |

Baud rate	4800
Handshake	none
Parity	none
Data bits	8
Stop bits	1
Record	none

- | | |
|---|--|
| 5 | Start the data transmission with  . After the transmission is finished the test report is deleted in the thermoreactor. |
|---|--|

5.6 Settings

5.6.1 Editing a temperature program





The temperature programs 1 to 8 are installed permanently and cannot be changed.

The temperature programs 9 to 16 and the temperature test program can be edited according to individual requirements.



Note

For the temperature test program, a TFK CR external temperature probe is required (available as an accessory, see chapter 9 ACCESSORIES/OPTIONS).

1	Switch to the Standby mode.
2	Keep the  key depressed while you press  to switch to the <i>SETUP</i> menu. <i>SETUP</i> and, in the second line, an editable parameter are displayed.
3	Using   select a temperature program no. 9 to 16 or the temperature test program.





```

SETUP
T: 80°C    0:30
  
```

4	Using  edit the selected temperature program. The two parameters, temperature and time, are displayed. The editing is marked on the display by *. The selected parameter is marked by an arrow < or >.
---	--



```

SETUP      *
T: 80°C < 0:30
  
```

5	Using   change the parameter (e.g. temperature).
6	Using   switch to the other parameter.

```





SETUP      *
T: 80°C > 0:30
  
```

7	Using   change the parameter (e.g. reaction time).
8	Using  confirm the changes. The marking on the display (*) disappears.

- | | |
|---|--|
| 9 | Using  leave the <i>SETUP</i> menu.
The changes are stored.
The thermoreactor is switched on (operation mode: program selection). |
|---|--|

5.6.2 Setting the display contrast

The display contrast can be set in 10 steps.

- | | |
|---|--|
| 1 | Switch to the Standby mode. |
| 2 | Keep the  key depressed while you press  to switch to the <i>SETUP</i> menu.
<i>SETUP</i> and, in the second line, an editable parameter are displayed. |
| 3 | Using   select <i>CONTRAST</i> . |

```

SETUP
CONTRAST:5





```

- | | |
|---|---|
| 4 | Using  edit the contrast setting.
The editing is marked on the display by*. |
|---|---|

```

SETUP      *
CONTRAST:5

```





- | | |
|---|--|
| 5 | Using   set the contrast from 0 to 9. |
| 6 | Using  confirm the changes.
The marking on the display (*) disappears. |
| 7 | Using  leave the <i>SETUP</i> menu.
The changes are stored.
The thermoreactor is switched on (operation mode: program selection). |

5.6.3 Setting the timer for the reaction time

After the start of a temperature program the thermoblock starts heating up. Depending on the setting, the timer for the reaction time starts automatically after the reaction temperature has been reached or only after confirmation by keypressing.

With the setting *START TIMER:AUTO* the timer for the reaction time starts immediately after the reaction temperature has been reached.





With the setting *START TIMER:MAN.* the timer for the reaction time starts after confirmation by keypressing only.

1	Switch to the Standby mode.
2	Keep the  key depressed while you press  to switch to the <i>SETUP</i> menu. <i>SETUP</i> and, in the second line, an editable parameter or a temperature program are displayed.
3	Using   select <i>START TIMER.</i>

```

SETUP
START TIMER:MAN.

```

4	Using  set the start of the timer for the reaction time. The editing is marked on the display by *.
5	Using   select <i>MAN.</i> or <i>AUTO.</i>
6	Using  confirm the changes. The marking on the display (*) disappears.
7	Using  leave the <i>SETUP</i> menu. The changes are stored. The thermoreactor is switched on (operation mode: program selection).

6 Maintenance, cleaning, disposal

6.1 Maintenance

The CR 4200 thermoreactor is maintenance-free.

6.2 Exchanging the fuses

- 1 Disconnect the line power cable from the thermoreactor.

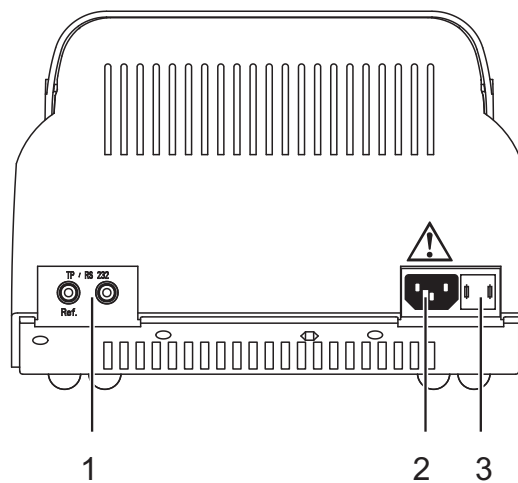

- 2 Pull out the fuse holder (3).
- 3 Exchange one or both fuses (6.3 AT).
- 4 Turn the fusion holder (3) so that the arrow on the housing points to the line voltage (115 or 230 V) provided by the power line.
- 5 Push the fusion holder (3) completely in.

6.3 Cleaning the enclosure

Wipe the thermoreactor with a damp cloth.



Caution

The housing is made of synthetic material. Thus, avoid contact with acetone or detergents that contain solvents. Remove any splashes immediately.

6.4 Cleaning the thermoblock of spilled cell contents

If liquid penetrated a thermoblock (e.g. from a cell), clean the thermoblock as follows:



Warning

Cells can contain poisonous or corrosive substances. If the content has been set free observe the danger notes on the cell. If necessary take the corresponding protective measures (protective goggles, protective gloves etc.).



Warning

The thermoblock can become very hot (170 °C). There is danger of burning when the thermoblock is heated up.

1	Switch off the thermoreactor and disconnect the power plug.
2	Allow the thermoreactor to cool down.
3	Unscrew the cover plate on top of the thermoblocks.
4	Clean the cover plate, block surfaces and borings with a damp cloth.
5	Screw on the cover plate again.



Note

Discoloration that remains on the thermoblock and cover plate does not affect the functioning of the thermoreactor.

6.5 Disposal

Dispose of the thermoreactor as electronic waste at an appropriate collection point. It is illegal to dispose of the thermoreactor in household refuse.

7 What to do if...

There is nothing on the display

Cause	Remedy
<ul style="list-style-type: none"> – The power supply is interrupted 	<ul style="list-style-type: none"> – Check mains cable and connections – Exchange the fuses – Repair by service department

Bars are displayed instead of the temperature (-°C)

Cause	Remedy
<ul style="list-style-type: none"> – With an active temperature test program: the signal of the external temperature probe was not recognized 	<ul style="list-style-type: none"> – Connect the temperature probe – Repair by service department
<ul style="list-style-type: none"> – In the program selection mode: internal temperature probe defective 	<ul style="list-style-type: none"> – Repair by service department

Temperature deviation during the temperature test program

Cause	Remedy
<ul style="list-style-type: none"> – Bad thermal contact between the external temperature probe and the thermoblock 	<ul style="list-style-type: none"> – Use original accessories only – Close the protection cover during the temperature test – Contact the service department

Cuvette emptied / thermoblock contaminated

Cause	Remedy
<ul style="list-style-type: none"> – e. g. leaking cuvette 	<ul style="list-style-type: none"> – see section 6.4

8 Technical Data

Reactor type	Dry temperature control device with safety cover
Cell shafts	2 x 12 cell shafts for reaction cells 16 ± 0.2 mm
Reaction time setting	20 min, 30 min, 60 min, 120 min (via fixed programs) 8 freely adjustable programs: 0...180 min
Temperature setting	100 °C, 120 °C, 148 °C, 150 °C via fixed programs and 8 freely adjustable programs: Room temperature ...170 °C
Controlling accuracy	± 1 °C ± 1 Digit
Temperature stability	± 0.5 K
Overtemperature protection	190 °C ± 5 °C
Heating time (with empty thermoblock) from 25 °C to	100 °C approx. 5 min 120 °C approx. 7 min 148 °C approx. 10 min
Temperature of the enclose at an environmental temperature of 25 °C	< 30 °C with a block temperature of 148 °C
Output	unidirectional RS232 interface with 2 banana sockets for: <ul style="list-style-type: none"> ● external temperature probe or <ul style="list-style-type: none"> ● PC cable
Power supply	230 VAC 50 Hz ± 15 % 115 VAC 60 Hz ± 15 % Power consumption: 560 W Fuses 2 x 6.3 AT
Enclosure	PC ABS, recyclable, high temperature resistant
Protective class	I according to DIN VDE 0700 part 1/11.90

Insulation group	Insulation group: B according to DIN VDE 0110/11.72
Overvoltage category	II
Protection	IP 20 according to DIN 40050
Ambient temperature	Storage -25 °C to +65 °C Operation +5 °C to +40 °C
Climatic class	2 according to VDI/VDE 3540 Relative humidity: Yearly mean: < 75 % 30 days /year: 95 % Other days: 85 % Light dew: yes
EMC	EN61326 FCC Class A
Test certificates	cETLus, CE
Dimensions	D x W x H: 312 x 255 x 185 mm
Weight:	4 kg
Safety standards	EN61010 UL3101 CAN/CSA C22.2-1010 EN61010-2-010 IEC-CAN/CSA C22.2-1010.2.010

9 Accessories/Options

Designation	Accessory
TFK CR	External temperature probe for the monitoring of test equipment of the CR 3200 and CR 4200 thermoreactors
AK CR/PC	PC cable for thermoreactors, CR 3200 and CR 4200

10 Index

A

Authorized use8

C

Commissioning11

Components of the thermoreactor6

Control lamps (LEDs)17

D

Display17

F

Fuses29

K

Keys16

M

Maintenance29

O

Operating and display elements15

Operating modes18

Operating safety8

Outputting data to a PC24

Outputting data to a printer24

P

PC24

Program selection18

S

Safety measures7

Scope of delivery11

Setting the display contrast27

Standby18

T

Temperature program

 editing26

 starting19

 stopping22

Temperature program active18

Temperature test program

 starting 23

Trouble shooting 31

W

What to do if... 31

11 Contact Information

11.1 Ordering & Technical Support

Telephone: (800) 897-4151
(937) 767-7241
Monday through Friday, 8:00 AM to 5:00 PM ET

Fax: (937) 767-1058

Email: environmental@ysi.com

Mail: YSI Incorporated
1725 Brannum Lane
Yellow Springs, OH 45387
USA

Internet: www.ysi.com

When placing an order please have the following information available:

YSI account number (if available)	Name and Phone Number
Model number or brief description	Billing and shipping address
Quantity	Purchase Order or Credit Card

11.2 Service Information

YSI has authorized service centers throughout the United States and Internationally. For the nearest service center information, please visit www.ysi.com and click 'Support' or contact YSI Technical Support directly at 800-897-4151.

When returning a product for service, include the Product Return form with cleaning certification. The form must be completely filled out for an YSI Service Center to accept the instrument for service. The Product Return form may be downloaded at www.ysi.com and clicking on the 'Support' tab.

Xylem

- 1) The tissue in plants that brings water upward from the roots;
- 2) a leading global water technology company.

We're 12,500 people unified in a common purpose: creating innovative solutions to meet our world's water needs. Developing new technologies that will improve the way water is used, conserved, and re-used in the future is central to our work. We move, treat, analyze, and return water to the environment, and we help people use water efficiently, in their homes, buildings, factories and farms. In more than 150 countries, we have strong, long-standing relationships with customers who know us for our powerful combination of leading product brands and applications expertise, backed by a legacy of innovation.



YSI
1725 Brannum Lane
Yellow Springs, OH 45387
Tel: +1 937-767-7241; 800-765-4974
Fax: +1 937-767-1058
Email: environmental@ysi.com
Web: www.ysi.com

a xylem brand

©Xylem Inc, October 2012